

My Home Learning Book!

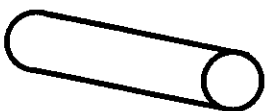

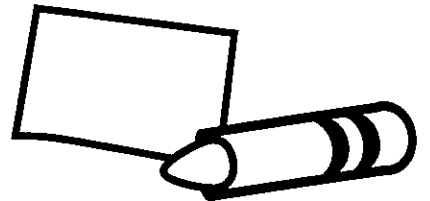

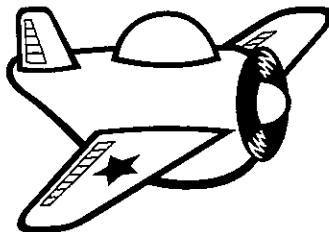
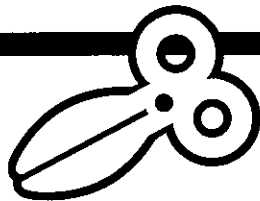
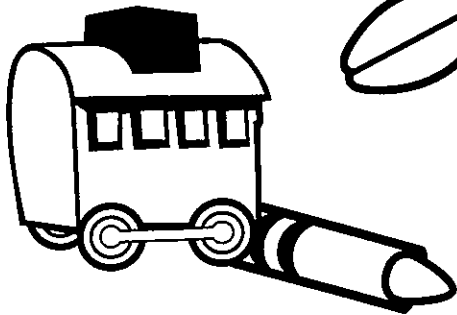
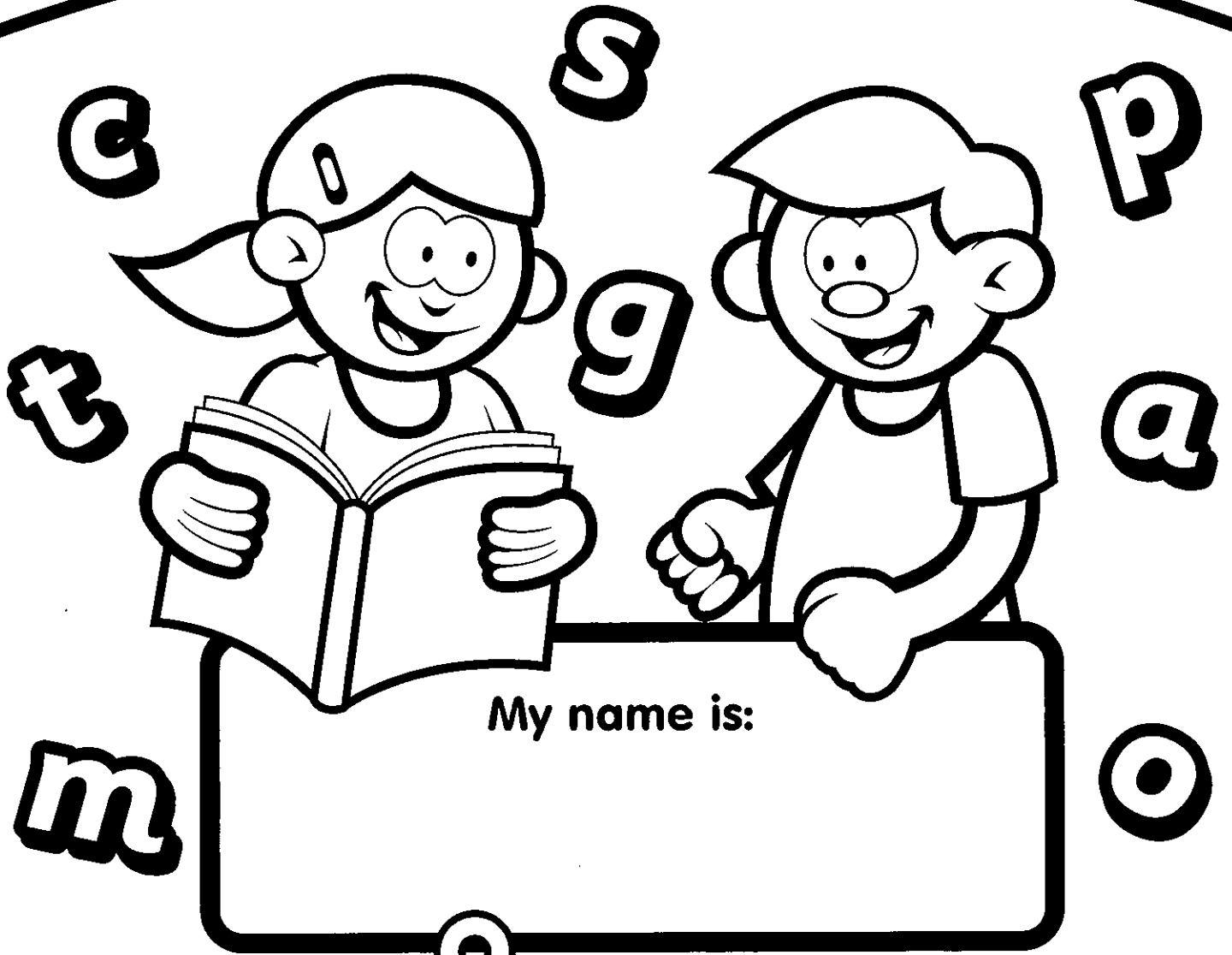
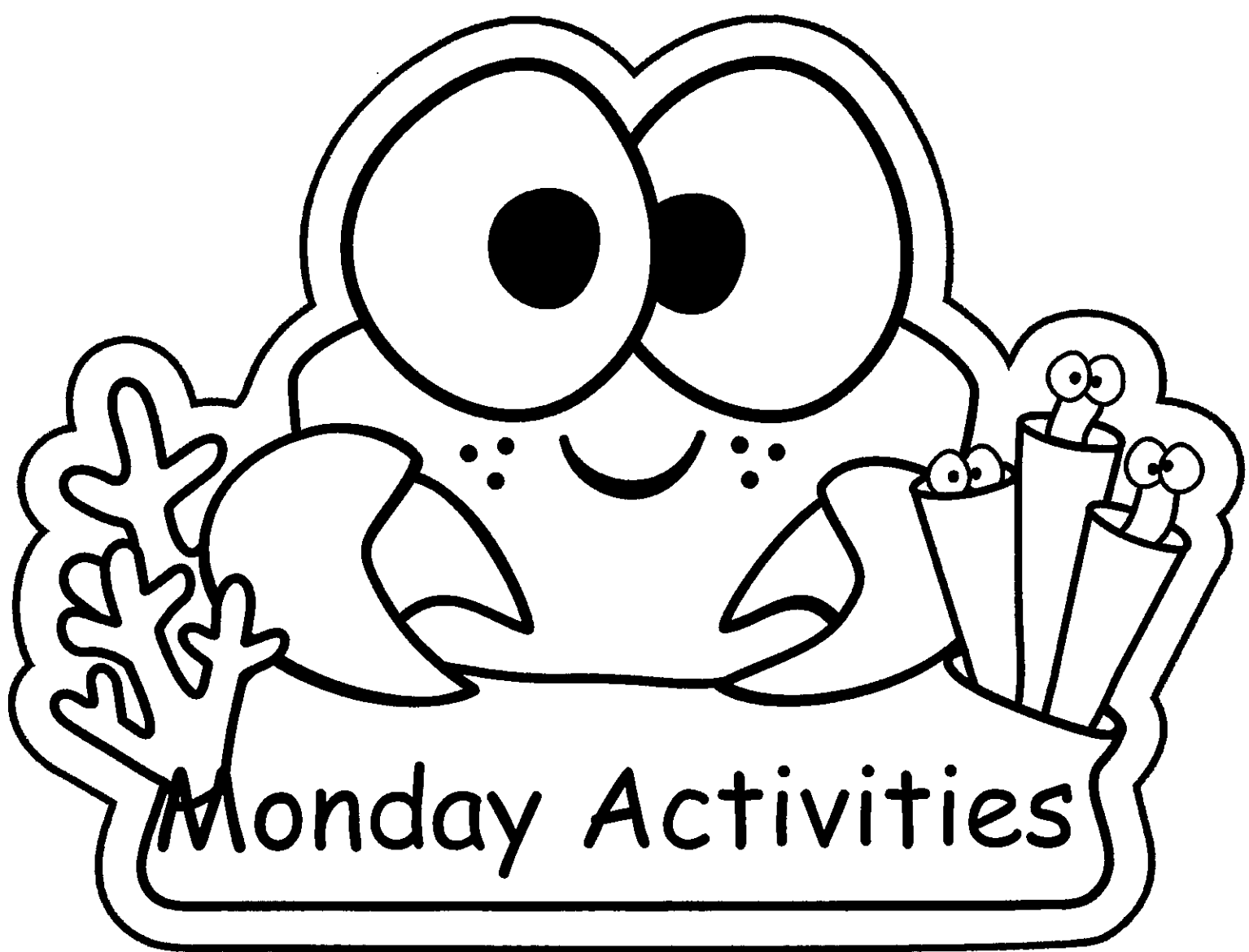

Monday Activities

HOW MANY SYLLABLES?

1 2 3 4

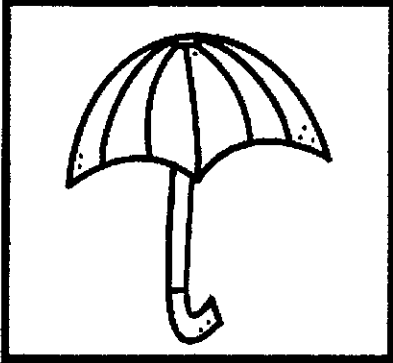

1 2 3 4

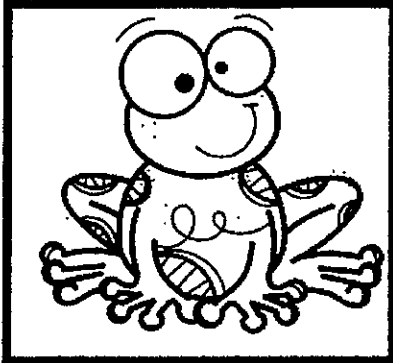

1 2 3 4

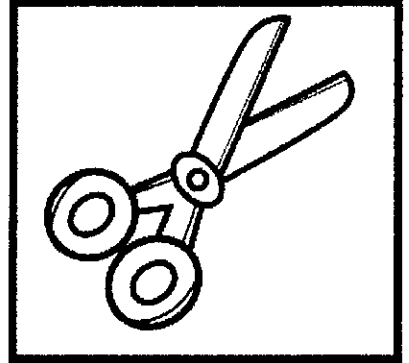

1 2 3 4

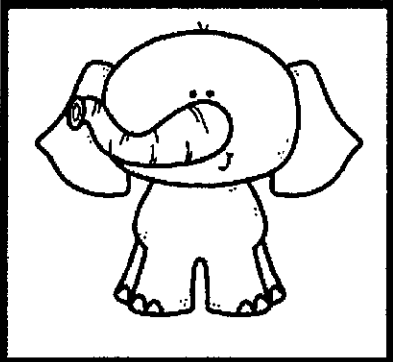

1 2 3 4

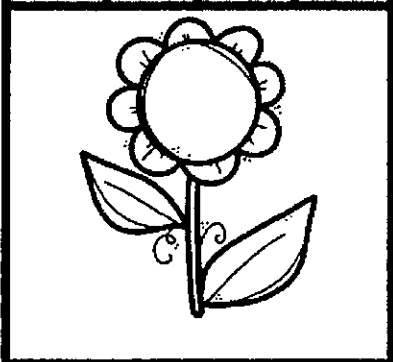

1 2 3 4

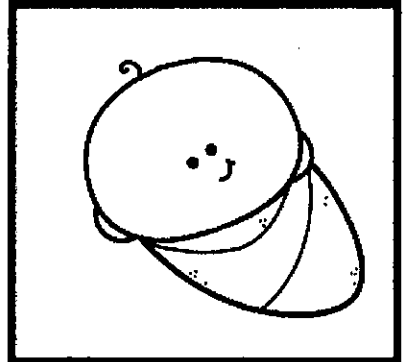

1 2 3 4

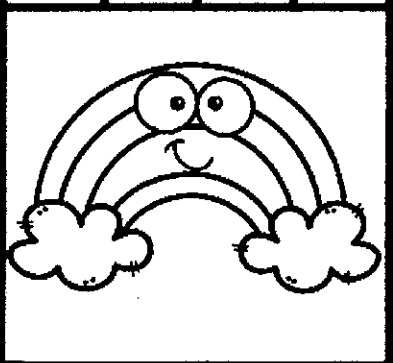

1 2 3 4

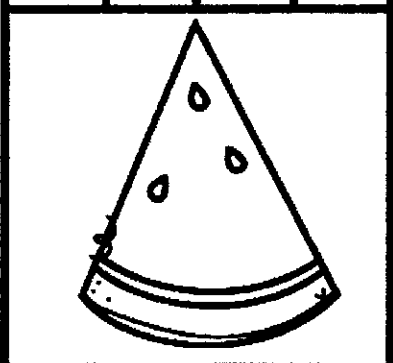

1 2 3 4

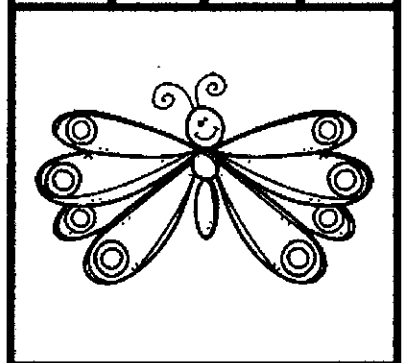

Decodable Sentence Jumble

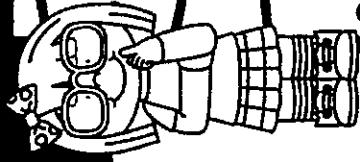

Name: _____

Which one ?

Read the sentences and tick the sentence that matches the picture.

	The hat is in the pan.	
	The ham is in the pan.	

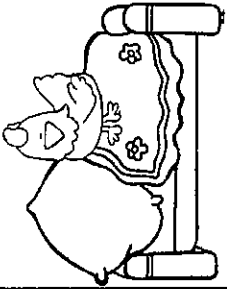

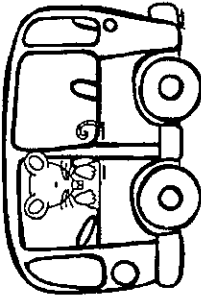

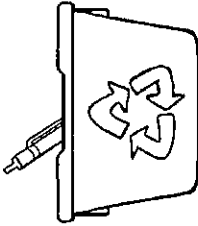

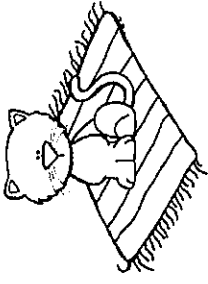

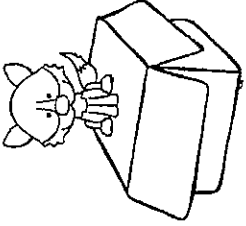









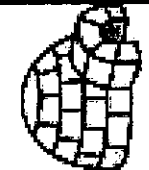

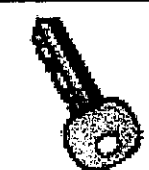



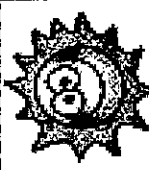

	The hen is on the bed.	
	The hen is in the pen.	

	The rat is in the van.	
	The bat is in the van.	

	The pen is in the pin.	
	The pen is in the bin.	



	The cat sat on the map.	
	The cat sat on the mat.	

	The fox is on the box.	
	The fox is on the log.	

Aa		Bb		Cc		Dd	
Ee		Ff		Gg		Hh	
Ii		Jj		Kk		Ll	
Mm		Nn		Oo		Pp	
Qq		Rr		Ss		Tt	
Uu		Vv		Ww		Xx	
Yy		Zz		ALPHABET			

This week, we are learning about seagulls. Use the picture, and the words below to write an information report on seagulls.



<p>? What type of animal is it?</p> <p>sea bird</p>	<p> What does it look like?</p> <p>white body grey wings</p> <p>yellow beak small claws</p>
<p> Where does it live?</p> <p>beach ocean</p>	<p>What does it eat?</p> <p>small fish crabs molluscs</p>

My Hundreds Chart

NAME: _____

DATE: _____

MY HUNDREDS Chart

NAME: _____

DATE: _____

1	2	3	4	5	6	7	8	9	10
11	12	13	14	15	16	17	18	19	20
21	22	23	24	25	26	27	28	29	30
31	32	33	34	35	36	37	38	39	40
41	42	43	44	45	46	47	48	49	50
51	52	53	54	55	56	57	58	59	60
61	62	63	64	65	66	67	68	69	70
71	72	73	74	75	76	77	78	79	80
81	82	83	84	85	86	87	88	89	90
91	92	93	94	95	96	97	98	99	100

Name: _____

Addition



Add the numbers to find the sum. Color the cherries.

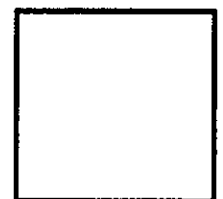
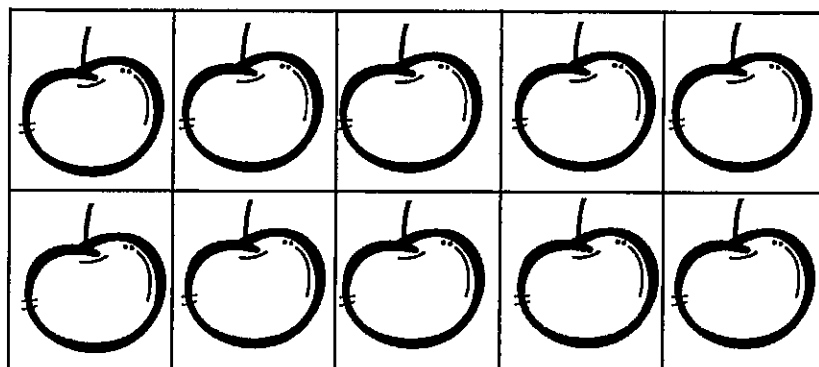
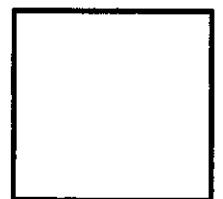
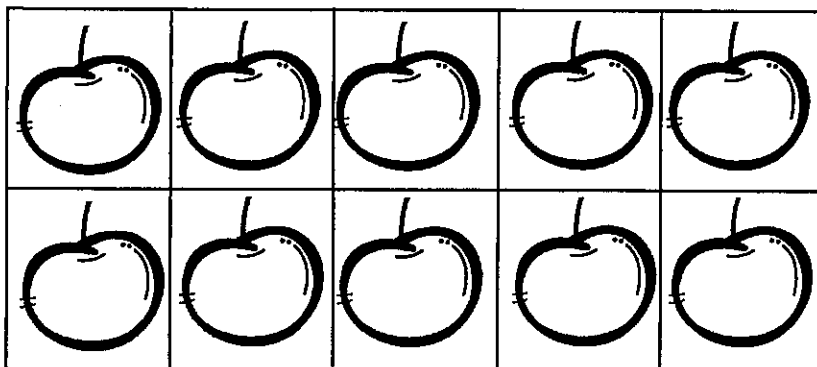
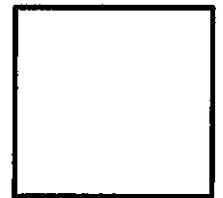
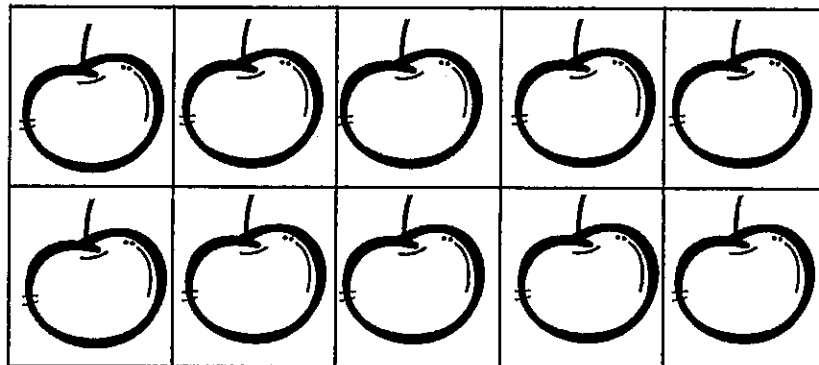
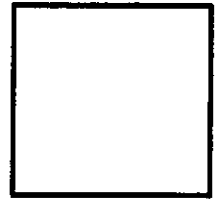
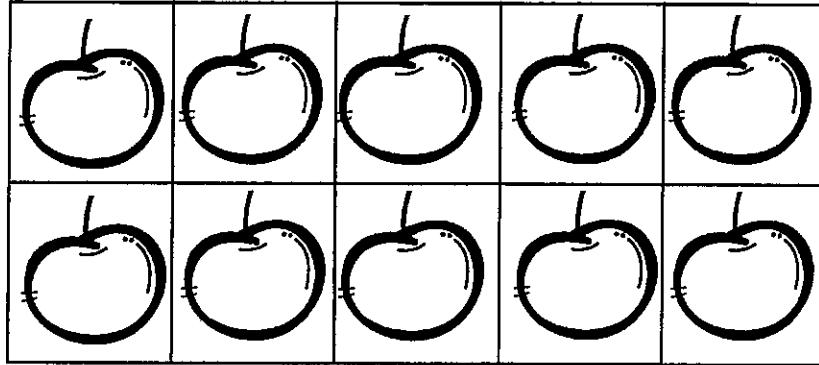

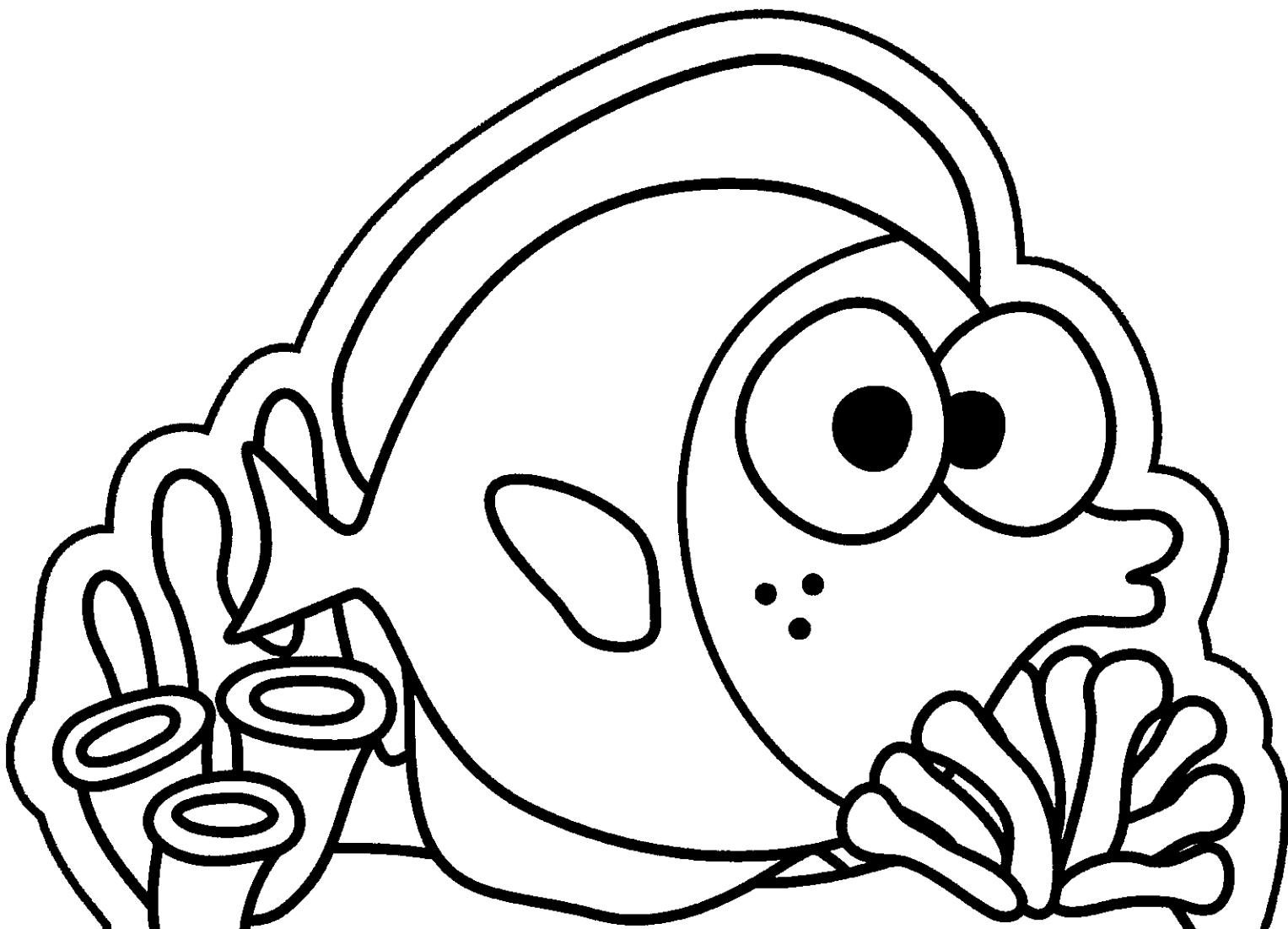

Tuesday Activities

HOW MANY SYLLABLES?

1 2 3 4

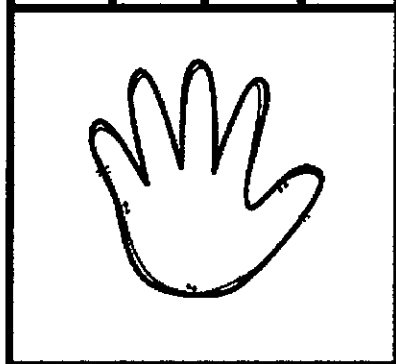

1 2 3 4

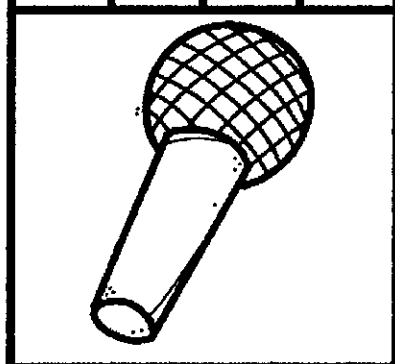

1 2 3 4

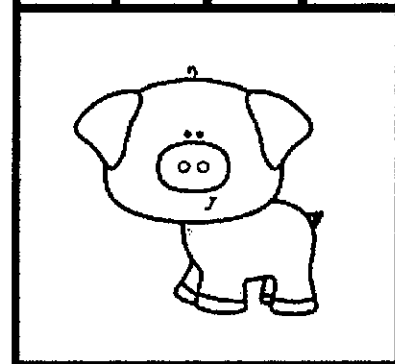

1 2 3 4

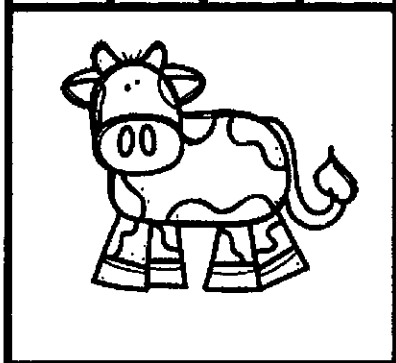

1 2 3 4

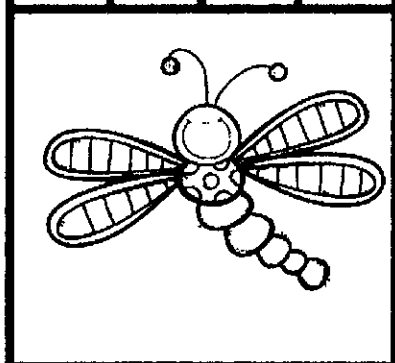

1 2 3 4

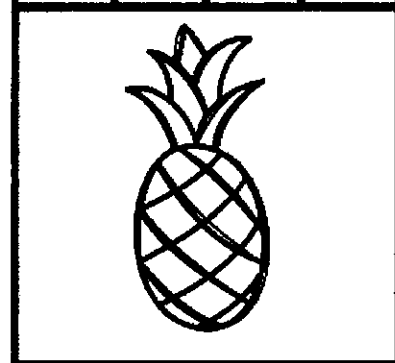

1 2 3 4

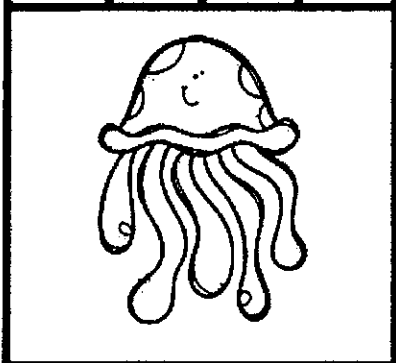

1 2 3 4

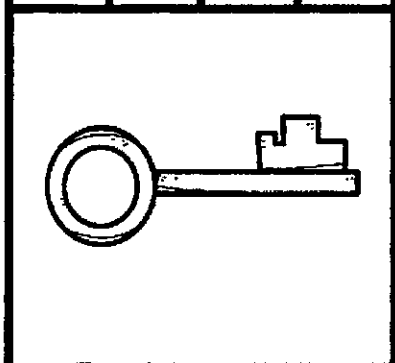

1 2 3 4

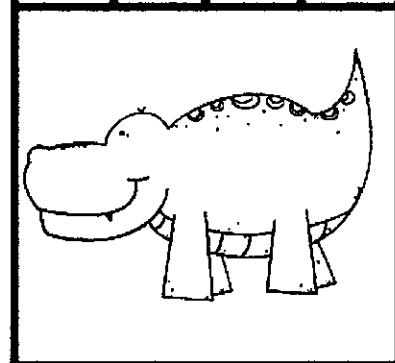

Decodable Sentence Jumble

Name: _____

Which one?

Read the sentences and tick the sentence that matches the picture.

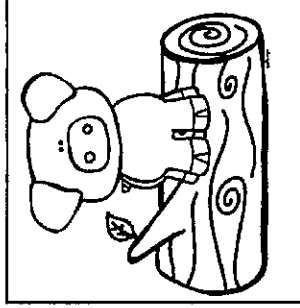

The pig is on the log.

The pin is on the log.

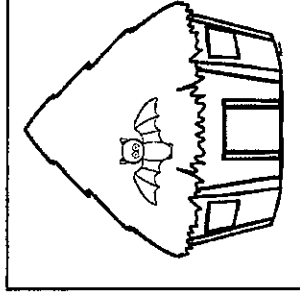

The bat is on the hut.

The rat is on the hut.

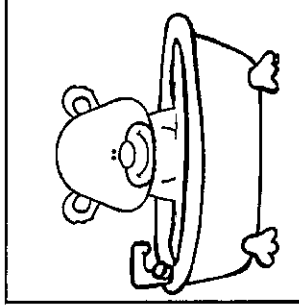

The bub is in the tub.

The cub is in the tub.

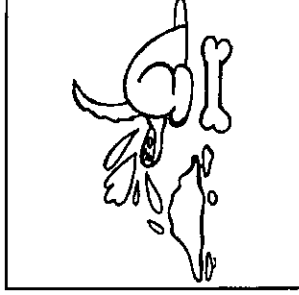

The dog likes to jig.

The dog likes to dig.

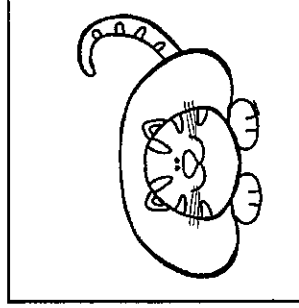

The fit cat sat.



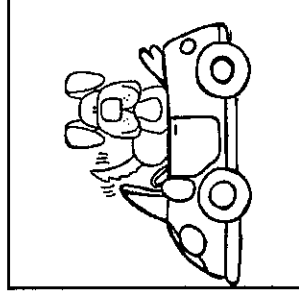





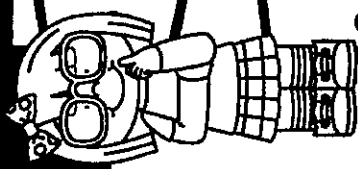



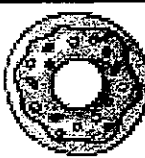



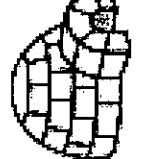

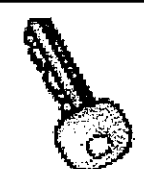

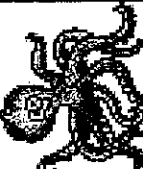
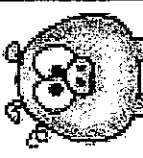

The fat cat sat.



The dog is in a car.



The bog is in a car.



 Aa	 Bb	 Cc	 Dd
 Ee	 Ff	 Gg	 Hh
 Ii	 Jj	 Kk	 Ll
 Mm	 Nn	 Oo	 Pp
 Qq	 Rr	 Ss	 Tt
 Uu	 Vv	 Ww	 Xx
 Yy	 Zz	ALPHABET	

This week, we are learning about seagulls. Use the picture, and the words below to write an information report on seagulls.



<p>? What type of animal is it?</p> <p>sea bird</p>	<p> What does it look like?</p> <p>white body grey wings</p> <p>yellow beak small claws</p>
<p> Where does it live?</p> <p>beach ocean</p>	<p>What does it eat?</p> <p>small fish crabs molluscs</p>

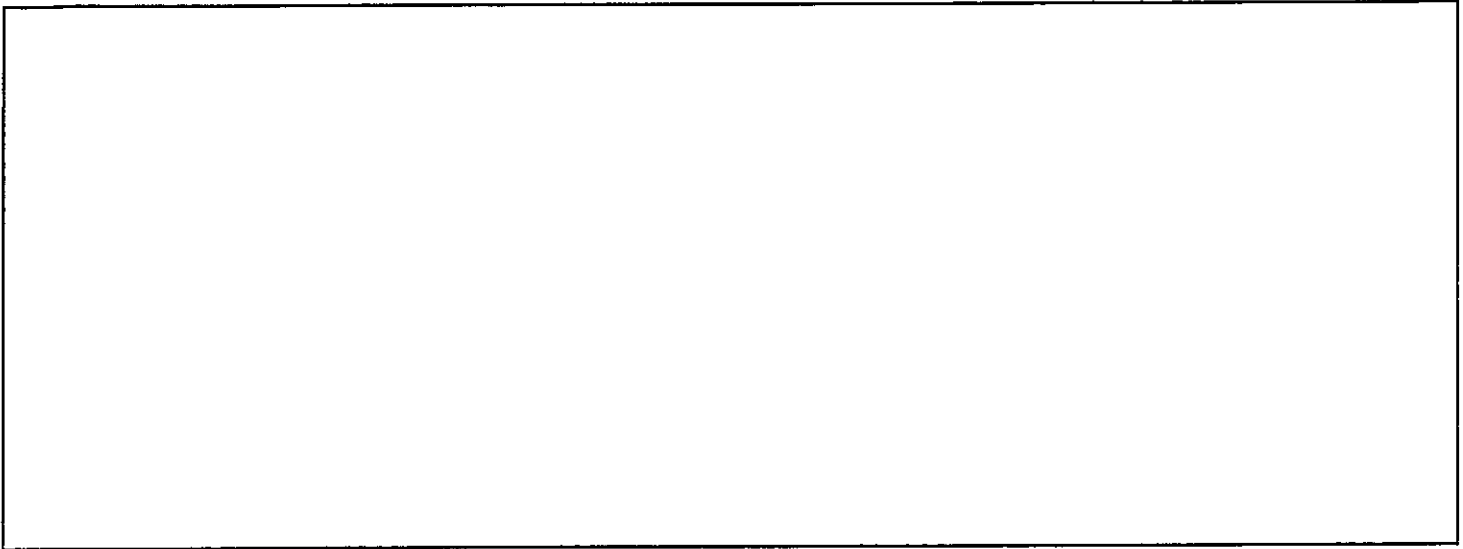



visit [twinkl.com](https://www.twinkl.com)



MY HUNDREDS CHART

NAME: _____

DATE: _____

MY HUNDREDS CHART

NAME: _____

DATE: _____

1	2	3	4	5	6	7	8	9	10
11	12	13	14	15	16	17	18	19	20
21	22	23	24	25	26	27	28	29	30
31	32	33	34	35	36	37	38	39	40
41	42	43	44	45	46	47	48	49	50
51	52	53	54	55	56	57	58	59	60
61	62	63	64	65	66	67	68	69	70
71	72	73	74	75	76	77	78	79	80
81	82	83	84	85	86	87	88	89	90
91	92	93	94	95	96	97	98	99	100

COLOUR BY ADDITION!

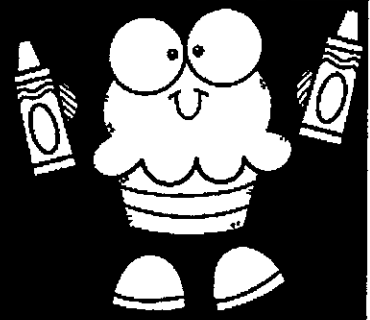

black = 3

blue = 6

yellow = 8

red = 5

green = 9

orange = 4

grey = 7

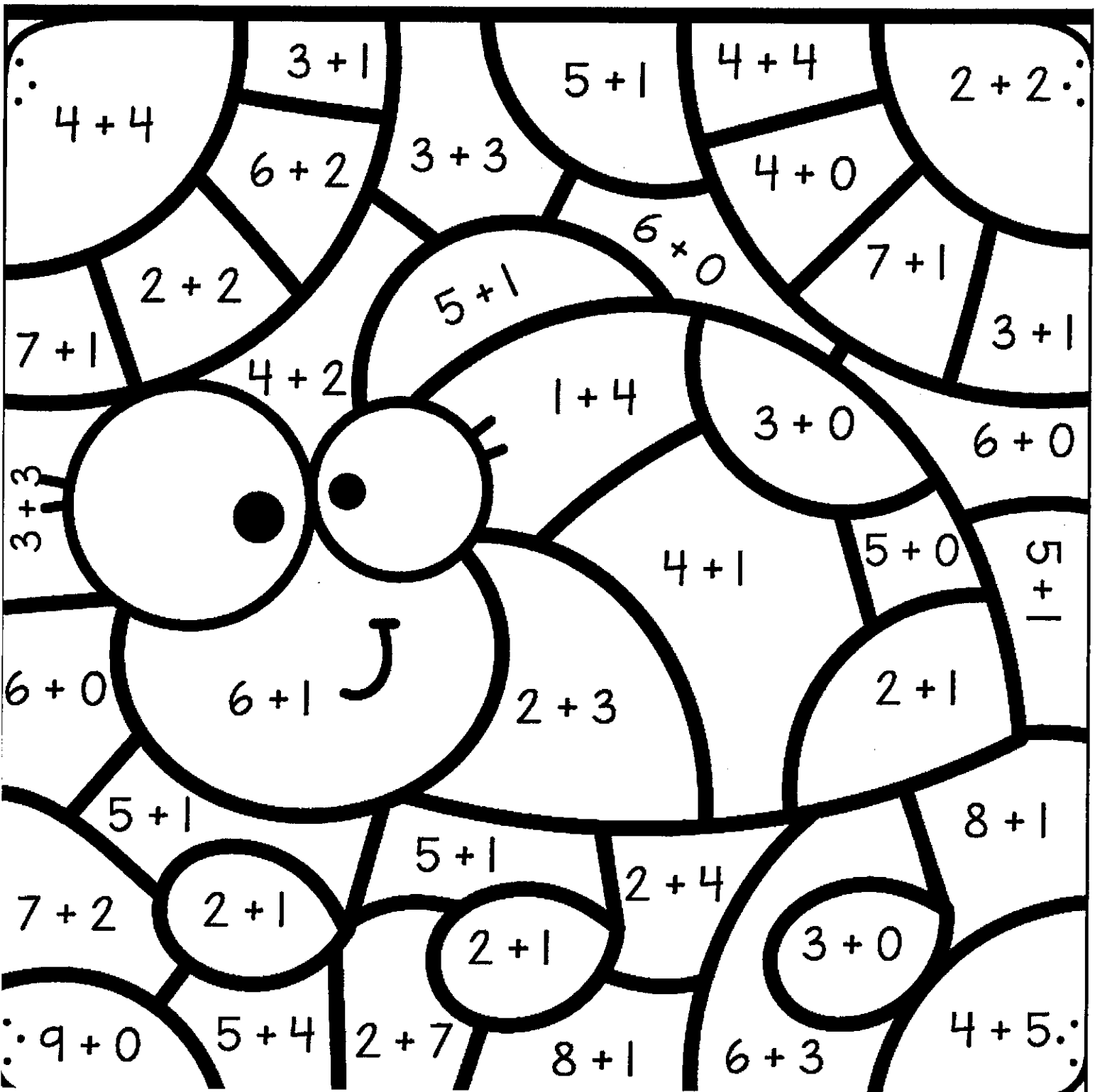



Wednesday Activities

Wellbeing Challenge

Physical	Emotional	Social	Cognitive	Spiritual
Design and complete a body weight circuit (of at least 10 activities) to participate in at home. <i>*Bonus 10 points if you get your family to do it with you*</i>	Draw how you are feeling.	Call, Skype or FaceTime a friend	Complete a mindfulness guided meditation. You can access these on Smiling Mind (You tube)	Participate in a yoga, Pilates or meditation session. There are some available on YouTube or you create your own.
Draw the fruit and vegetables you ate today. Can you label them? Did you eat 2 fruits and 5 vegetables?	Participate in a self-care activity e.g. going to bed early, painting, deep breathing, watching the sunset or having a bath.	Make a playlist of your top 10 songs and send it to a friend.	Look up origami and make a crane.	Complete some mindfulness colouring in (these can be found online)
Go on Youtube and try <u>The Body Coach</u>	Do something nice for a sibling or parent/carer	Make a card for a friend you are missing from school.	Make an art piece using nature.	Go on a nature walk, plant some seeds, listen to some birdsong or do some weeding.
Take your pet, teddy bear or sibling for a walk or bike ride.	Watch your favourite show/movie; then write down how it made you feel.	Play a board game with your family members.	Read your favourite story.	Make a list of 10 things you would like to do or a 'bucket list'
Create your own obstacle course.	Do the washing up today or help hand out the washing	Write a letter to someone about a happy memory you have shared together.	Complete a jigsaw puzzle.	Wake up early to watch the sunrise and see how beautiful it is.

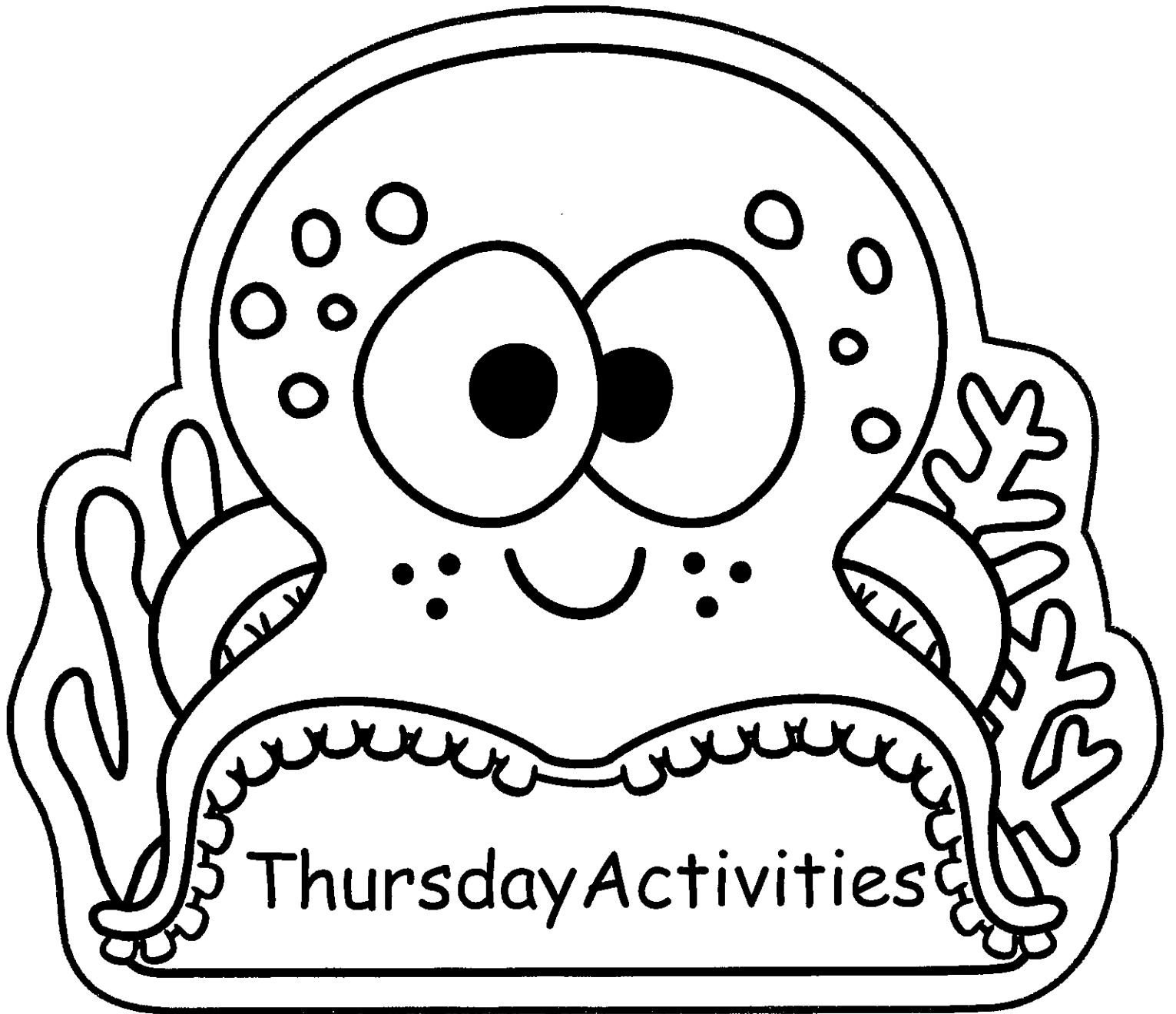

Thursday Activities

HOW MANY SYLLABLES?

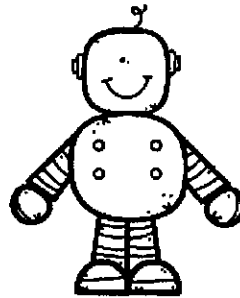
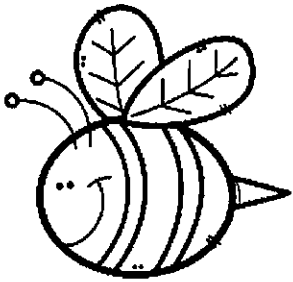
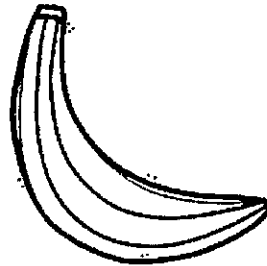
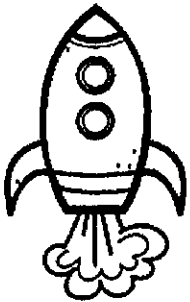
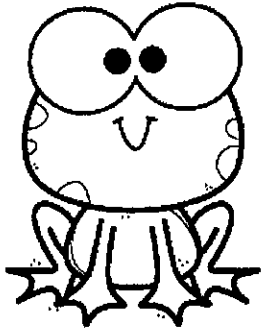

LOST LETTERS!

Can you fill in the missing letters?

C

J

O

E

N

S

V

Z























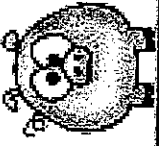

READ, WRITE & DRAW

I went to the shop.



This is my red fish.



Aa		Bb		Cc		Dd	
Ee		Ff		Gg		Hh	
Ii		Jj		Kk		Ll	
Mm		Nn		Oo		Pp	
Qq		Rr		Ss		Tt	
Uu		Vv		Ww		Xx	
Yy		Zz		ALPHABET			

This week, we are learning about seagulls. Use the picture, and the words below to write an information report on seagulls.



? What type of animal is it?

sea bird



What does it look like?

white body

grey wings

yellow beak

small claws



Where does it live?

beach

ocean

What does it eat?

small fish

crabs

molluscs

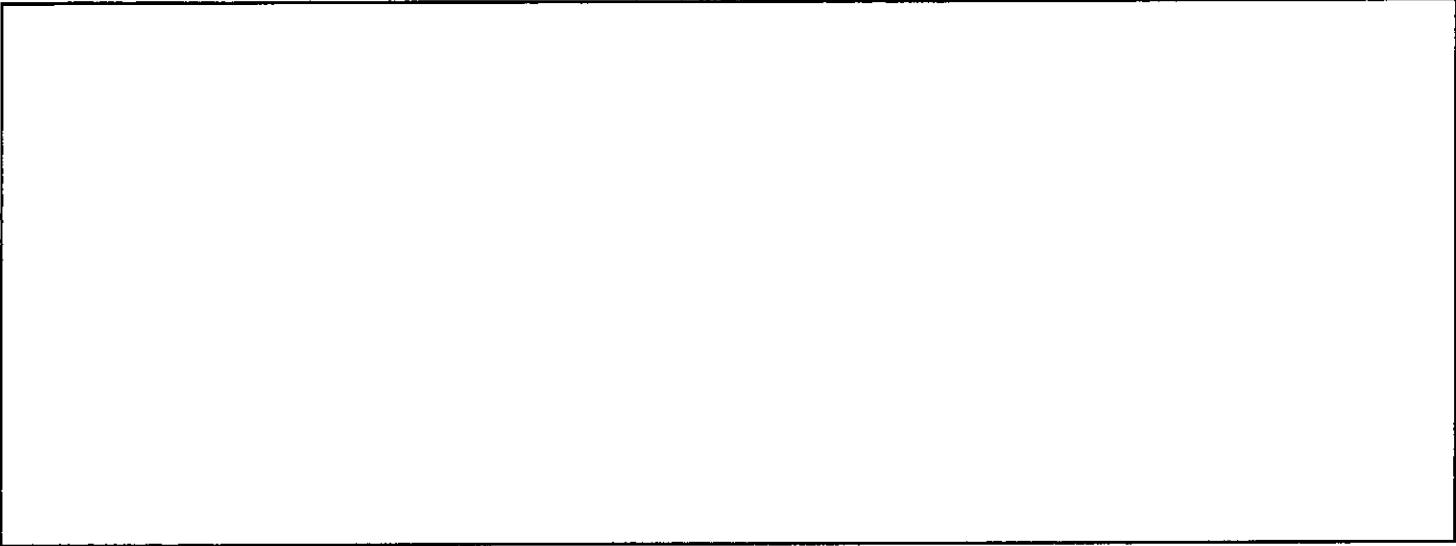

My Hundreds Chart

NAME: _____

DATE: _____

MY HUNDREDS CHART

NAME: _____

DATE: _____

1	2	3	4	5	6	7	8	9	10
11	12	13	14	15	16	17	18	19	20
21	22	23	24	25	26	27	28	29	30
31	32	33	34	35	36	37	38	39	40
41	42	43	44	45	46	47	48	49	50
51	52	53	54	55	56	57	58	59	60
61	62	63	64	65	66	67	68	69	70
71	72	73	74	75	76	77	78	79	80
81	82	83	84	85	86	87	88	89	90
91	92	93	94	95	96	97	98	99	100

Name _____

Making Ten with Gumball Machines

Draw the missing gumballs so that each machine has 10 gumballs.

Write the missing number in the box.

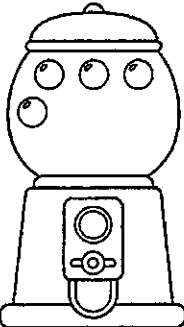

$4 + \square = 10$

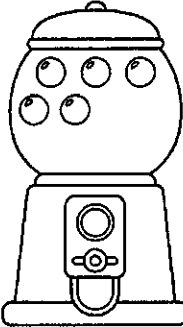

$5 + \square = 10$

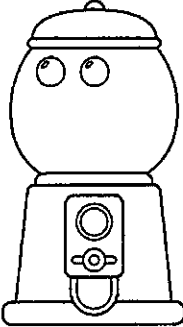

$2 + \square = 10$

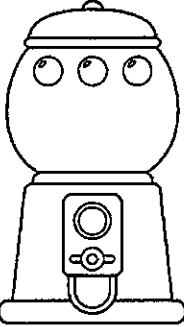

$3 + \square = 10$

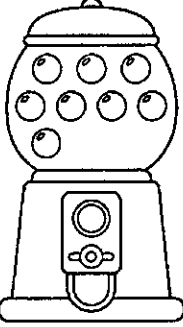

$8 + \square = 10$

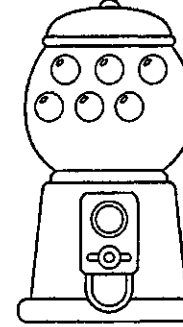

$6 + \square = 10$

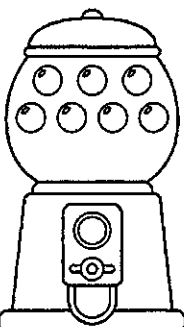

$7 + \square = 10$

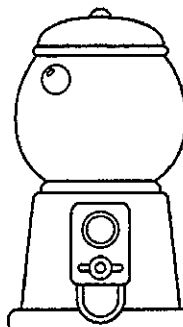

$1 + \square = 10$

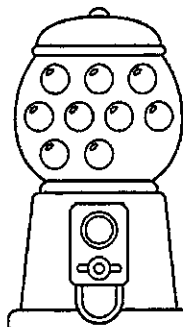

$9 + \square = 10$



Friday Activities

HOW MANY SYLLABLES?

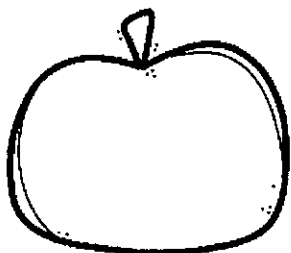
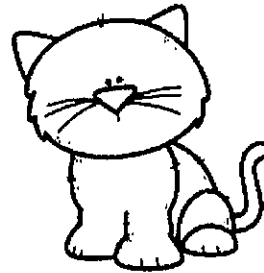
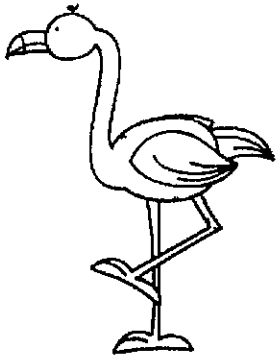
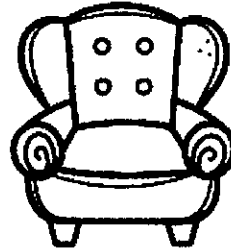



LOST LETTERS!

Can you fill in the missing letters?

d

k

o

a

g

s

z

READ, WRITE & DRAW

They are going to the ship.





That red shell is for you.

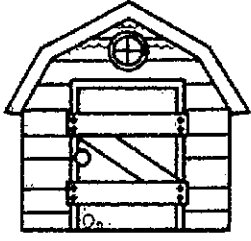

UNJUMBLE ME!

	sh	d	e

	sh	p	o

	o	ch	p



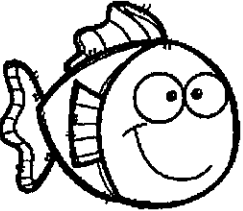

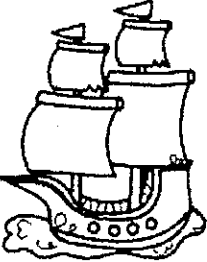









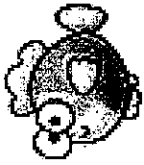

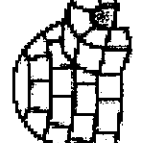

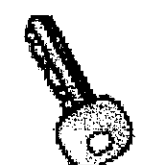
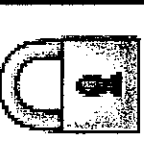



	m	th	o

	f	sh	i

	sh	p	i



	sh	d	i

	sh	t	u

Aa		Bb		Cc		Dd	
Ee		Ff		Gg		Hh	
Ii		Jj		Kk		Ll	
Mm		Nn		Oo		Pp	
Qq		Rr		Ss		Tt	
Uu		Vv		Ww		Xx	
Yy		Zz		ALPHABET			

This week, we are learning about seagulls. Use the picture, and the words below to write an information report on seagulls.



<p>? What type of animal is it?</p> <p>sea bird</p>	<p> What does it look like?</p> <p>white body grey wings</p> <p>yellow beak small claws</p>
<p> Where does it live?</p> <p>beach ocean</p>	<p> What does it eat?</p> <p>small fish crabs molluscs</p>

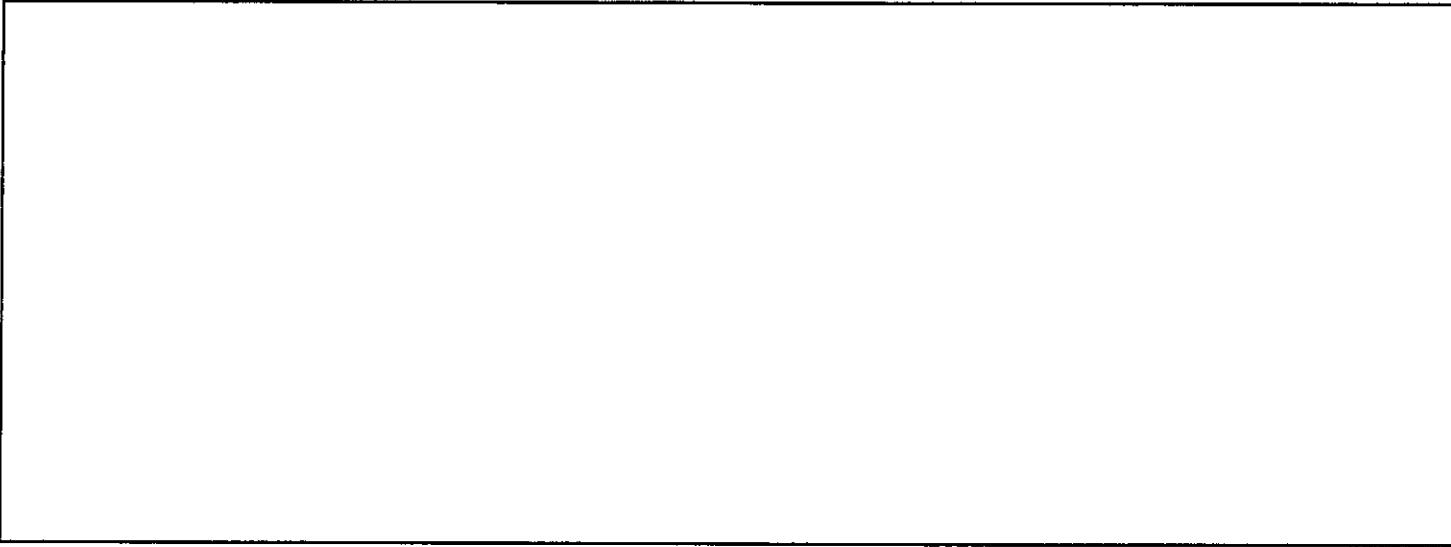

Handwriting practice lines consisting of 15 horizontal lines spaced evenly down the page.

My Hundreds Chart

NAME: _____

DATE: _____

MY HUNDREDS Chart

NAME: _____

DATE: _____

1	2	3	4	5	6	7	8	9	10
11	12	13	14	15	16	17	18	19	20
21	22	23	24	25	26	27	28	29	30
31	32	33	34	35	36	37	38	39	40
41	42	43	44	45	46	47	48	49	50
51	52	53	54	55	56	57	58	59	60
61	62	63	64	65	66	67	68	69	70
71	72	73	74	75	76	77	78	79	80
81	82	83	84	85	86	87	88	89	90
91	92	93	94	95	96	97	98	99	100

Name: _____

2D Shape Match

Color the objects that match the first shape.

